

Parameters Subject to Change Without Notice

FEATURES

- Controller for adaptive 100/120Hz current ripple remover
- Built-in zener diode for input voltage clamping
- VG output voltage high to 10V
- Programmable amplitude of LED current ripple
- Programmable maximum cathode voltage of LED
- Programmable maximum LED current
- Short protection
- Over temperature protection
- SOT23-6L Package

APPLICATIONS

- LED lighting

DESCRIPTION

JW1221 is a controller for driving external NMOSFET to remove the 100/120Hz LED current ripple on AC/DC power by a capacitor between VC and GND.

The adaptive technology of JW1221 ensures minimum power dissipation on NMOSFET while

removing LED current ripple.

JW1221 clamps the input voltage on VIN pin by 30V. Only one resistor is needed when the output voltage of AC/DC power is higher than 31V.

JW1221 allows user to setup maximum LED current by the sensing resistor between the source of NMOSFET and ground, which keeps NMOSFET damaged when LED short connected or hot-plug.

By sensing the drain voltage of NMOSFET via a resistor between the drain and VLMT pin, JW1221 allows user to setup the maximum cathode voltage of LED string, which could help limit the power dissipation on chip.

It is considered that LED is shorted when the cathode voltage of LED is higher than short connecting threshold and remains over 60us JW1221 shuts down NMOSFET when LED is shorted and recovers after 13ms.

JW1221 provides over thermal protection. When the temperature of JW1221 exceed 135°C, OTP is triggered. JW1221 shuts down NMOSFET until the temperature decrease to 110°C.

Company's Logo is Protected, "JW" and "JOULWATT" are Registered Trademarks of JoulWatt technology Inc.

TYPICAL APPLICATION

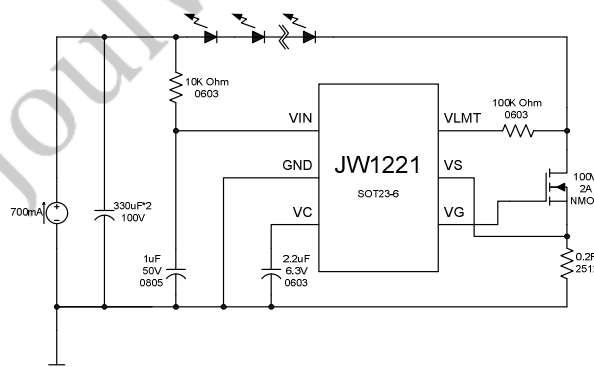

ORDER INFORMATION

PART MARKING	PACKAGE DESCRIPTION	Top Marking	Package Form
JW1221	SOT23-6L	JW1221	Tape and reel packaging: 3000 pieces/tape

PIN CONFIGURATION

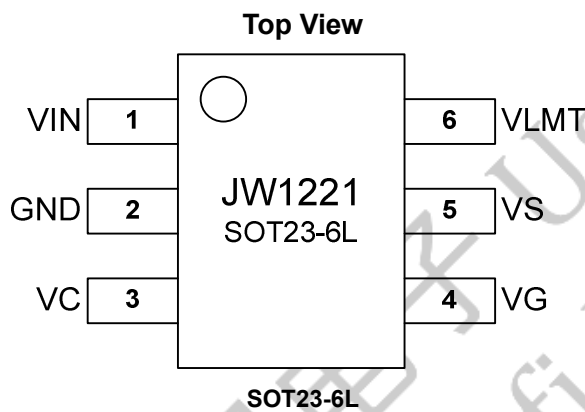

ABSOLUTE MAXIMUM RATING

VIN clamp voltage.....	31V
VG	20V
VS, VC, VLMT	-0.3V ~ 6V
Junction Temperature ^{2) 3)}	150°C
Lead Temperature	260 °C
Storage Temperature.....	-65 °C ~ +150 °C

RECOMMENDED OPERATING CONDITIONS

Maximum Junction Temperature (T_J)..... 150°C

THERMAL RESISTANCE

θ_{JA} θ_{JC}

SOT23-6L 50 ...10 °C /W

Note:

- 1) Exceeding these ratings may damage the device.
- 2) The JW1221 guarantees robust performance from -40°C to 150°C junction temperature. The junction temperature range specification is assured by design, characterization and correlation with statistical process controls.
- 3) The JW1221 includes thermal protection that is intended to protect the device in overload conditions. Thermal protection is active when junction temperature exceeds the maximum operating junction temperature. Continuous operation over the specified absolute maximum operating junction temperature may damage the device.
- 4) Measured on JESD51-7, 2-layer PCB.

ELECTRICAL CHARACTERISTICS

VIN = 12V, TA = 25°C, unless otherwise stated.

Item	Symbol	Condition	Min.	Typ.	Max.	Units
VIN clamp voltage	V _{IN_CLP}		29	31	33	V
VIN operation current	I _{IN}	5V<VIN<33V	0.24	0.3	0.58	mA
VIN startup voltage threshold	V _{THULVO}		15	16	17	V
VIN startup voltage hysteresis	V _{HYSUVLO}			5		V
Maximum VG output voltage	V _{VG}		9.5	10	10.5	V
VC startup current	I _{VCST}	VC short to GND when startup	0.7	0.8	0.9	mA
VLMT reference voltage	V _{VLMT}		1.95	2	2.05	V
NMOSFET drain voltage limit	V _{D_CLP}	Drain voltage of NMOSFET when voltage limit is triggered. R _{LIMIT} =100K.	3.4	4	4.6	V
SHORT protection threshold	V _{TH_SHORT}	Drain voltage of NMOSFET when SHORT is triggered. R _{LIMIT} =100K.	5	6	7.5	V
SHORT protection delay time	TSPD			60		us
SHORT protection hold time	TSPH			13		ms
VS voltage limit	V _{VS}		0.18	0.2	0.22	V

PIN DESCRIPTION

SOT23-6L Pin No.	Name	Description
1	VIN	Power Supply
2	GND	Ground
3	VC	LED Current Ripple Programming
4	VG	NMOSFET GATE driving voltage output
5	VS	LED current sensing input
6	VLMT	LED Voltage Limit and SHORT protection Programming

TYPICAL PERFORMANCE CHARACTERISTICS

$V_{IN} = 90\sim 264V_{AC}$, $V_{OUT} = 75V$, $I_{OUT} = 240mA$, $C_{OUT} = 100\mu F/100V \times 2$, $T_A = +25^\circ C$, unless otherwise noted

Pre-driver Output Steady State

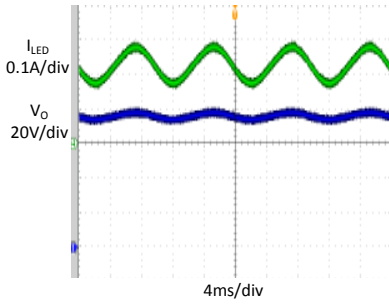

+JW1221 Output Steady State

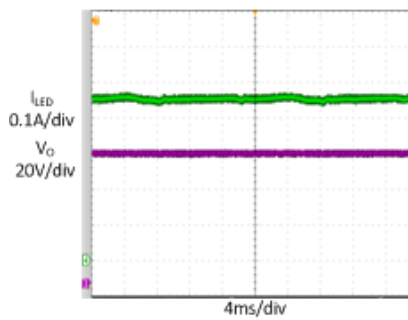

Efficiency comparison(with and without JW1221)

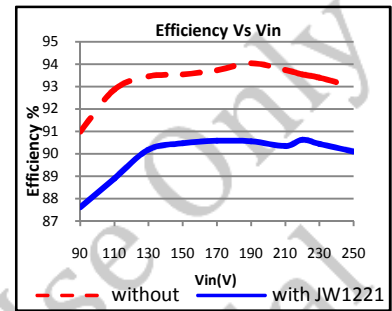

Open Circuit protection Test

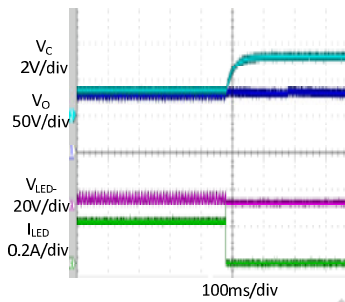

Short Circuit Protection Test

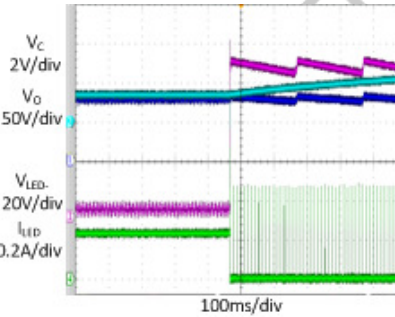

Continuous power on/off test

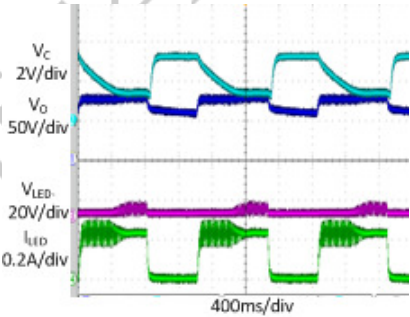

LED Hot plug

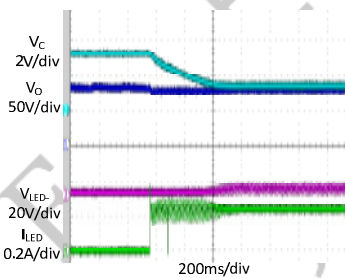

FUNCTIONAL DESCRIPTION

JW1221 is a controller for driving external NMOSFET to remove the 100/120Hz LED current ripple on AC/DC power.

Theory of Operation

The LED string and JW1221 are both supplied by an AC/DC current source. The drain of external NMOSFET is connected to the cathode of LED string. A sensing resistor R_{SENSE} is connected between the source of NMOSFET and GND. The gate is connected to the VG of JW1221.

JW1221 drives NMOSFET to transfer the LED current ripple to voltage ripple on NMOSFET, and ensures the constant voltage across LED string and the current flow through LED string. The scalable adaptive function of JW1221 can regulate the cathode voltage of LED string to minimum to improve the efficiency of the system.

Current Ripple Removing

The capacitor C_C between VC and GND is a integration capacitor. JW1221 transform the voltage on C_C to a reference voltage. The current regulator regulates the voltage on R_{SENSE} equal to the reference voltage. The relationship between the voltage on C_C and R_S is shown as following:

$$V_{RS} = I_{LED} * R_{SENSE} = V_{VC} / 10$$

C_C should be large enough in order to remove the current ripple of the LED string. However, too large capacitor may slow down the dynamic response.

Adaptive Regulation

JW1221 control the voltage on C_C by monitoring the operation state of external NMOSFET. The efficiency of system is relatively low when

NMOSFET is working in the saturation region. JW1221 detects it and charges C_C to raise the V_{VC} and I_{LED} , then the output voltage of power supply is reduced, and the voltage drop on NMOSFET decreases.

Conversely, when NMOSFET is working in the linear region, LED current regulation loop is open. JW1221 detects it and discharges C_C to reduce the V_{VC} and I_{LED} , then the output voltage of power supply is raised, and the LED current regulation loop is close.

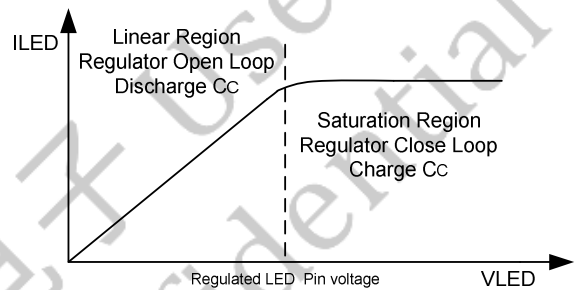

Drain Voltage of NMOSFET Limit

The voltage ripple on the drain of NMOSFET maybe very large when the current ripple is removed, which would bring large power dissipation on chip. The resistor between the drain of NOMSFET and VLMT pin can setup the limit value of drain voltage of NMOSFET.

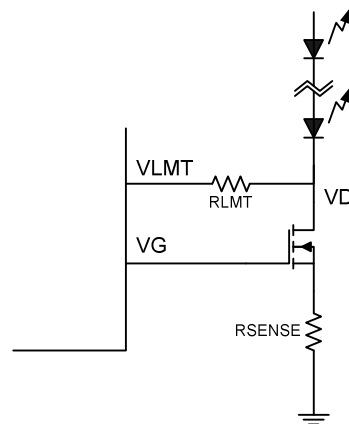

The limit threshold is calculated as below:

$$V_{\text{limit}} = 2V + R_{\text{LMT}} * 20\mu\text{A}$$

LED Current Limit

The voltage of VS pin is limited to 0.2V internally. So the current limitation is $0.2V/R_S$.

Current limit can protect the chip when LED is short connected or HOT-PLUG.

The function of current limit is higher priority than drain voltage limit. It means that the voltage on drain of NMOSFET is not limited when LED current exceed current limit threshold.

LED Short Protection

JW1221 detect SHORT by R_{LMT} . When the drain voltage of NMOSFET exceeds the SHORT PROTECTION THRESHOLD and the state holds for more than 60us, JW1221 considers

the LED string is SHORT connected, and shut down the external MOSFET. The SHORT state is reset after 13ms.

The SHORT PROTECTION THRESHOLD is calculated as:

$$V_{\text{THSCP}} = 2V + R_{\text{LMT}} * 40\mu\text{A}$$

Over Thermal Protection

JW1221 monitors operation temperature. When the temperature is higher than 135°C , the NMOSFET is shut down until the temperature decrease to 115°C .

PCB Design Guideline

1. The bypass capacitor of VIN should be placed as close as possible to the VIN pin and GND pin of IC.
2. JW1221 should be placed far away from the power devices such as MOSFET and SBD.
3. The area of LED current loop should be as small as possible.

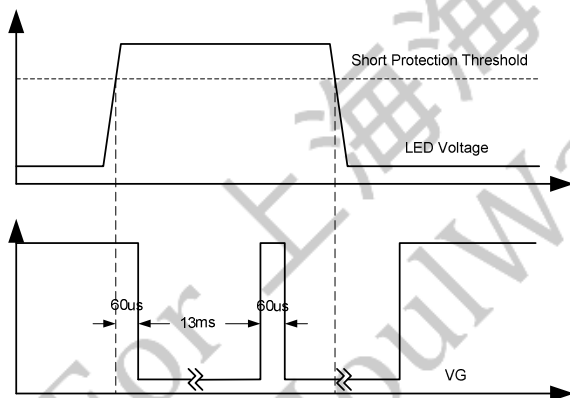

APPLICATION NOTE

JW1221 design guide:

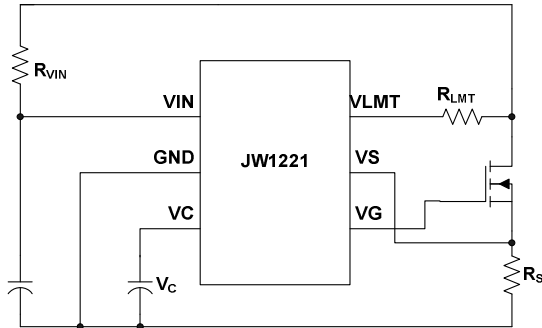

1. Because of the 30V zener integrated and the 4.6V V_{IN} start threshold, the value of R_{VIN} may satisfy the following conditions:

$$R_{VIN} < \frac{V_F - 4.6V}{0.5mA}$$

V_F : the voltage of LED

2. The maximum voltage of VS pin is 2V in order to limit the maximum output current especially in the short circuit condition. The value of R_S can be calculated as below:

$$R_S < \frac{0.2V}{I_{LED}}$$

I_{LED} : the output current of the pre-driver

3. When the voltage of LED- reaches V_{SCP} which is set by the R_{LMT} , JW1221 pulls down the VIN then turns off the MOSFET. In order to ensure nothing will be damaged in the short circuit condition, the value of R_{LMT} must satisfy the following conditions:

$$V_{OVP} - V_F < V_{SCP} < V_F$$

$$V_{SCP} < V_{INSTART} = R_{VIN} * 0.5mA + 4.6V$$

$$V_{SCP} = 2V + 40uA * R_{LMT}$$

V_{OVP} : the output voltage when the pre-driver is open.

V_{SCP} : the threshold of JW1221 short circuit protection.

$V_{INSTART}$: the output voltage of the pre-driver when the VIN of JW1221 is 4.6V.

4. The value of the capacitor between VC and GND can determine the final amplitude of the current ripple. It should be large enough in order to remove the current ripple of the LED string. However, too large capacitor may slow down the dynamic response. In normal condition, 1uF or 2.2uF is relatively reasonable.
5. To ensure JW1221 work properly, the R_{DSON} of MOSFET must be less than $3R_S$. The MOSFET will endure a large power shorting the output on the moment, so the appropriate package and R_{DSON} of the MOSFET is necessary.
6. When short the LED, there is an overshoot on the drain of the MOSFET. The breakdown voltage of the MOSFET must be higher than V_{OVP} . A diode connected to LED+&LED- can reduce the overshoot when short.

PACKAGE OUTLINE

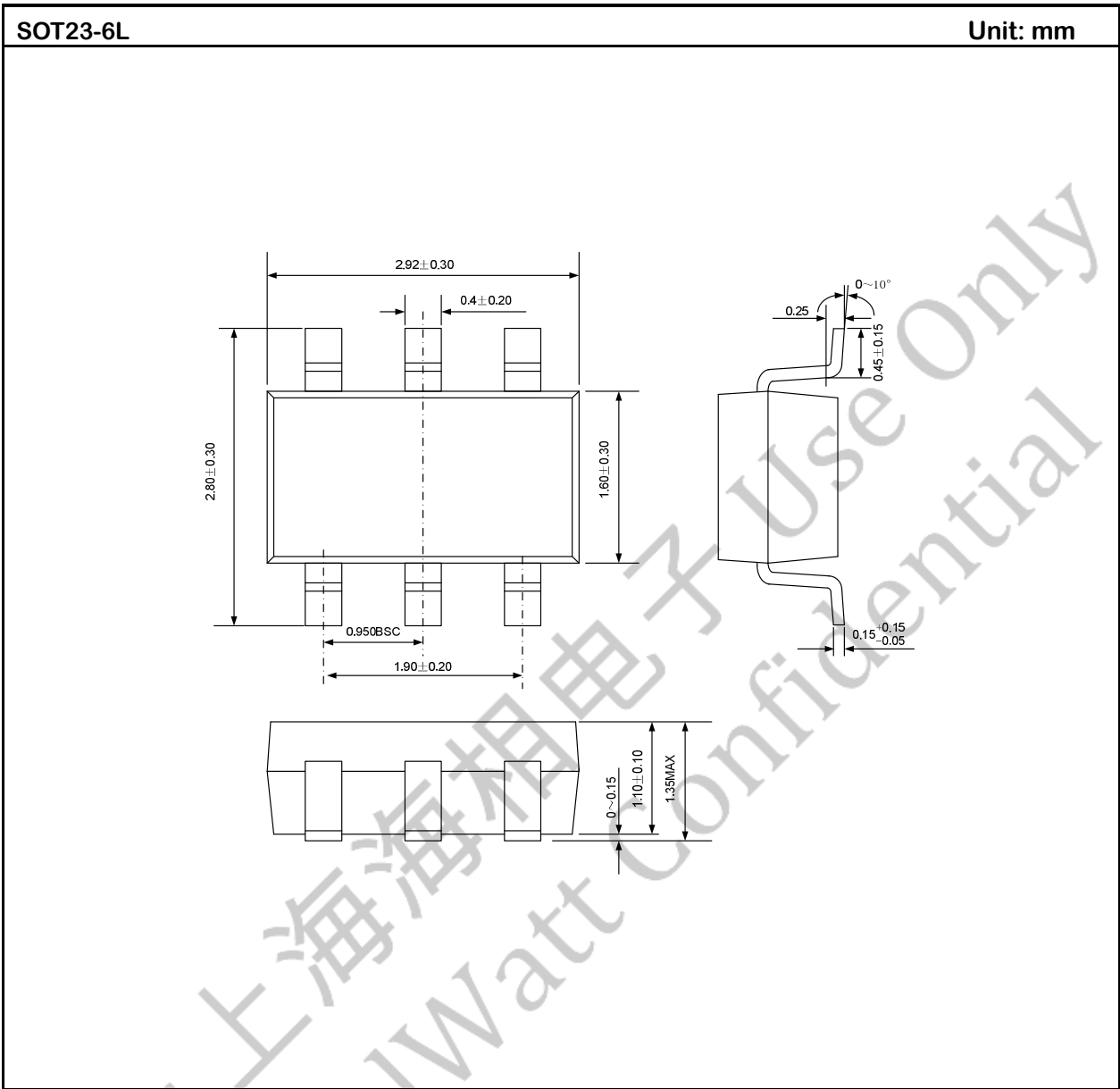

IMPORTANT NOTICE

- Joulwatt Technology Inc. reserves the right to make modifications, enhancements, improvements, corrections or other changes without further notice to this document and any product described herein.
- Any unauthorized redistribution or copy of this document for any purpose is strictly forbidden.
- Joulwatt Technology Inc. does not warrant or accept any liability whatsoever in respect of any products purchased through unauthorized sales channel.
- When using this product, Joulwatt Technology Inc. has no responsibility for any direct or indirect loss caused by the use of the product or attached material.

For 上海海相电子 Use Only
JoulWatt Confidential

Copyright © 2014 JW1221 Incorporated.

All rights are reserved by Joulwatt Technology Inc.