

## Dual-Channel CC/CV Mode

# Synchronous Step-Down Converter

### DESCRIPTION

The EUP3468A is a dual-channel synchronous step-down converter capable of driving 5A continuous load with excellent line and load regulation. The EUP3468A operates in either CC (Constant Current) mode or CV (Constant Voltage) mode with an input voltage range from 8V to 36V. The EUP3468A can be configured as single output or dual outputs with independent programmable CC threshold for current limitation. The EUP3468A provides programmable cable compensation by adjusting external resistor divider. External shutdown function can be controlled by pulling COMP pin to a level below 0.14V. The EUP3468A stops switching when the output reaches over voltage threshold which is set by internal resistor divider.

Fault protection includes secondary cycle-by-cycle current limit, short circuit protection and thermal shutdown. Internal soft-start minimizes the inrush supply current and the output overshoot at initial startup.

The EUP3468A is available in SOP-8 (EP) package.

### FEATURES

- 8V to 36V Wide Input Operating Range
- 40V Input Voltage Surge
- 80kHz~800kHz Switching Frequency Selection
- Dual Channel CC/CV Mode Control
- Up to 5A Output Current
- +/- 1% Voltage Reference Accuracy
- +/- 4% Constant Current Accuracy
- Programmable Cable Compensation
- Internal Soft Start
- Single Pin to External Compensation and Shutdown Control
- Output Over Voltage Protection
- Hiccup Short Circuit Protection
- Secondary Cycle-by-Cycle Current Limit
- Thermal Shutdown
- Available in SOP-8 (EP) Package
- RoHS Compliant and 100% Lead(Pb)-Free Halogen-Free

### APPLICATIONS

- Car Charger
- Portable charger applications
- DC/DC converters with current limited

### Typical Application Circuit

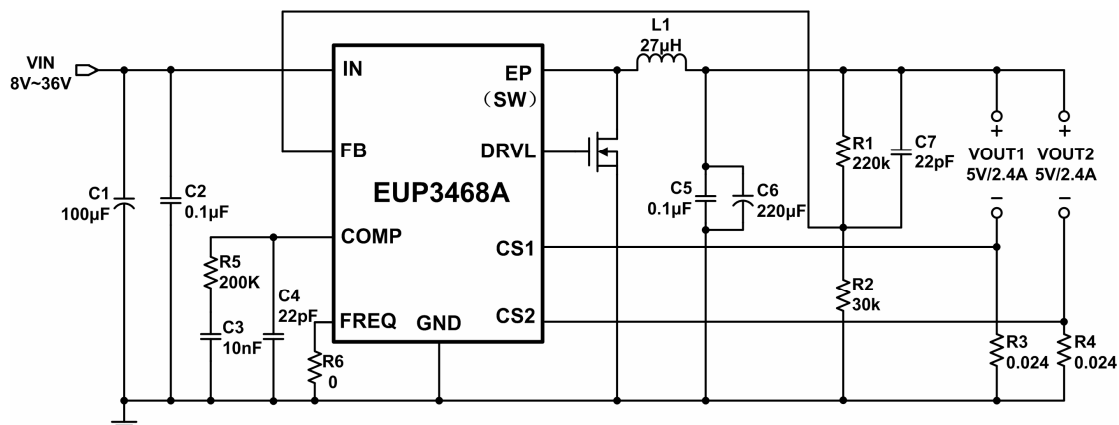

Figure 1. Application Circuit

## Block Diagram

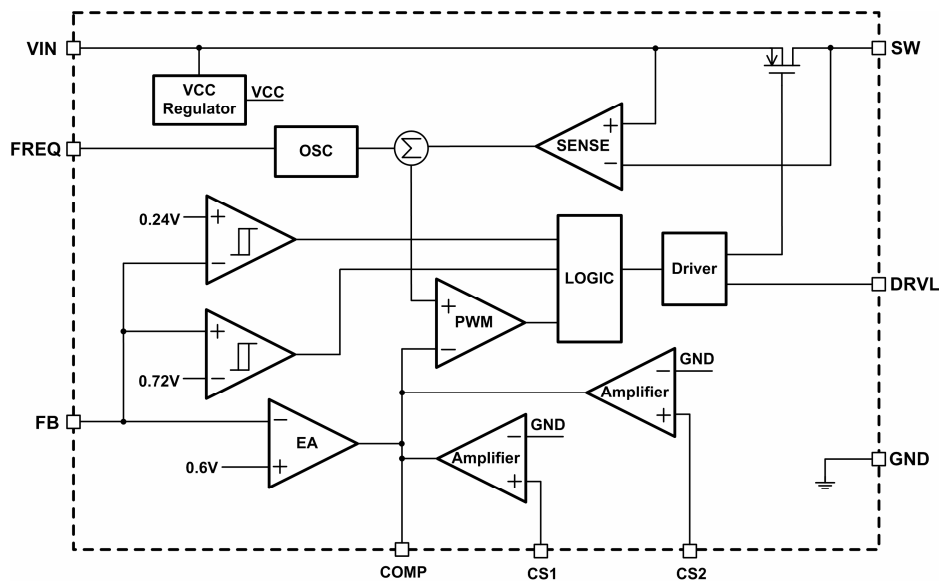

Figure 2. Functional Block Diagram

## Pin Configurations

Package Type	Pin Configurations
SOP-8 (EP)	<p>(Top View)</p>

## Pin Description

Pin Name	SOP-8 (EP)	DESCRIPTION
VIN	1	Input Supply Pin.
GND	2	Ground.
COMP	3	Loop compensation pin. Drive COMP voltage logic low to turn off the converter.
FB	4	Output Feedback Input.
CS1	5	Channel 1 current sense input pin.
CS2	6	Channel 2 current sense input pin.
FREQ	7	Frequency select pin.
DRVL	8	Low-side switch drive pin.
SW	EP	Power switch pin.

## Ordering Information

Order Number	Package Type	Marking	Quantity per Reel	Operating Temperature Range
EUP3468AWIR1	SOP-8 (EP)	 XXXXX 3468A	2500	-40°C to +85°C

EUP3468A

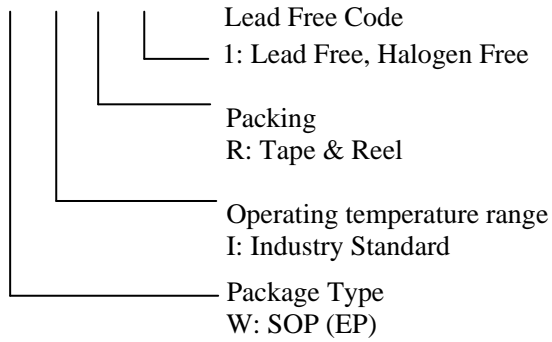

## Absolute Maximum Ratings (1)

■ Input Voltage ( $V_{IN}$ ) -----	-0.3V to 40V
■ Switch Voltage ( $V_{SW}$ ) -----	-1V to $V_{IN} + 0.3V$
■ CS1, CS2, DRV1 -----	-0.3V to 13V
■ All Other Pins -----	-0.3V to 6V
■ Junction Temperature -----	150°C
■ Storage Temperature -----	-65°C to +150°C
■ Lead Temp(Soldering, 10sec) -----	260°C
■ Thermal Resistance $\theta_{JA}$ (SOP-8_EP) -----	60°C/W

## Recommend Operating Conditions (2)

■ Supply Voltage ( $V_{IN}$ ) -----	8V to 36V
■ Operating Temperature Range -----	-40°C to +85°C

Note (1): Stress beyond those listed under “Absolute Maximum Ratings” may damage the device.

Note (2): The device is not guaranteed to function outside the recommended operating conditions.

## Electrical Characteristics

( $V_{IN}=12V$ ,  $T_A=+25^\circ C$ ,  $I_{OUT}=2.0A$ , unless otherwise specified)

Parameter	Conditions	EUP3468A			Unit
		Min.	Typ.	Max.	
Input voltage		8		36	V
Input No Load Current	$I_{OUT}=0A$			10	mA
Quiescent Current	$V_{FB}=0.7V$		1		mA
Shutdown Current	$V_{COMP}=0V$		380		$\mu A$
Input Under Voltage Lockout Threshold Rising		6.2	6.7	7.2	V
Input Under Voltage Lockout Threshold Hysteresis			1		V
Current Limit			7.5		A
Operating frequency	$R6=0\Omega$	144	160	176	kHz
	$T_J = -25^\circ C$ to $125^\circ C$	136		184	
Maximum Duty Cycle				100	%
Minimum On-Time			400		ns
Reference Voltage of the Voltage Error Amplifier		0.594	0.6	0.606	V
	$T_J = -25^\circ C$ to $125^\circ C$	0.587		0.613	V
CS1/CS2 Reference Voltage		57.4	60	62.6	mV
	$T_J = -25^\circ C$ to $125^\circ C$	56.4		63.6	mV
Transconductance of Error Amplifier			75		$\mu A/V$
Reference Voltage of the Over Voltage Comparator		0.698	0.72	0.742	V
	$T_J = -25^\circ C$ to $125^\circ C$	0.691		0.749	V
Reference Voltage of the Short Circuit Foldback Comparator			0.24		V
COMP Enable Threshold Rising			0.14		V
COMP Enable Threshold Hysteresis			40		mV
Thermal Shut-down Temperature	Temperature Rising		150		$^\circ C$
	Temperature Falling		100		$^\circ C$
PMOS Drain-Source On-State Resistance	$V_{IN}=24V$ , $I_{OUT}=1A$			90	m $\Omega$

## Typical Operating Characteristics

$V_{IN}=12V$ ,  $V_{OUT}=5V$ ,  $T_A=25^{\circ}C$ , unless otherwise noted.

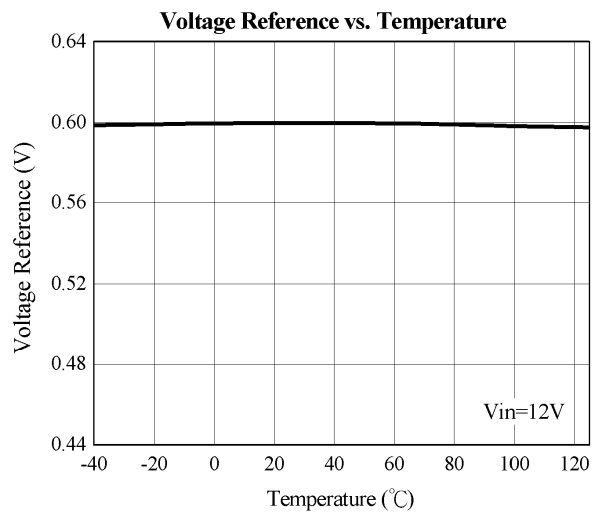
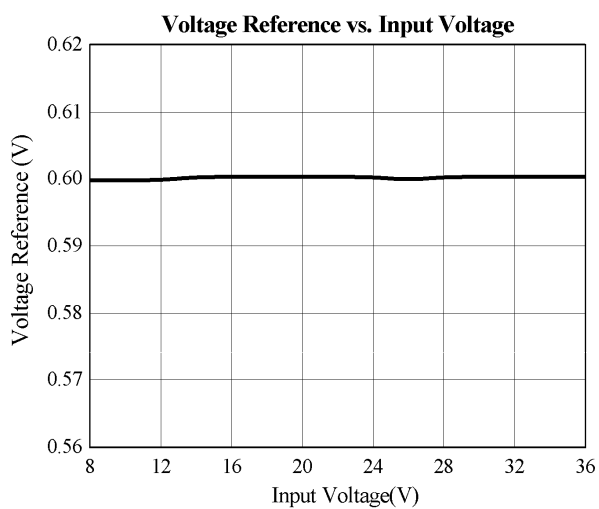
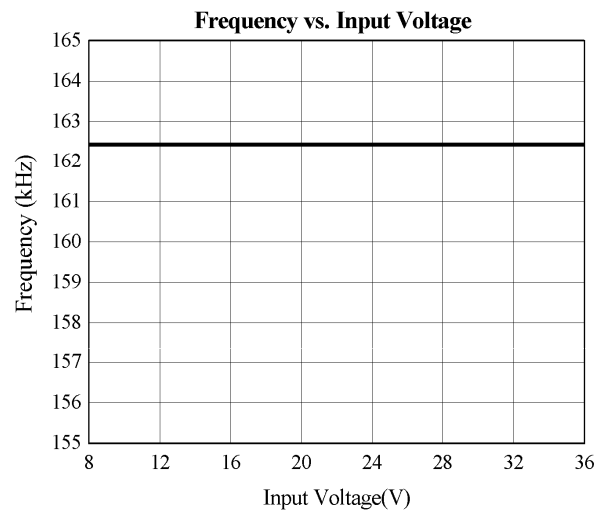
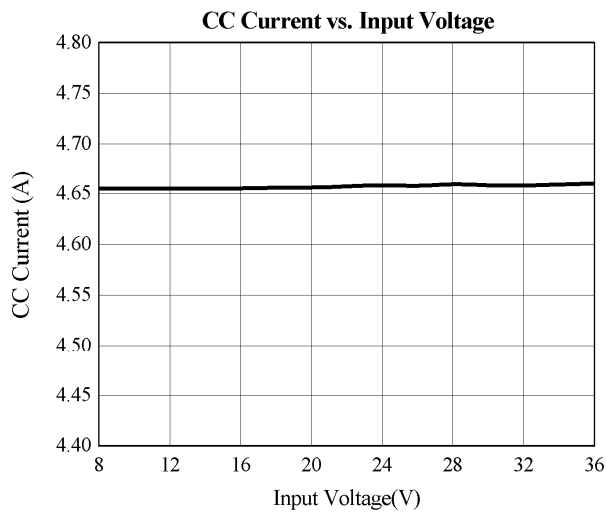
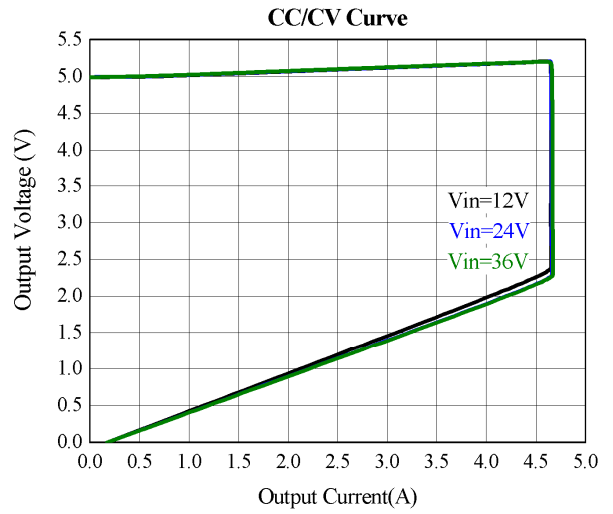
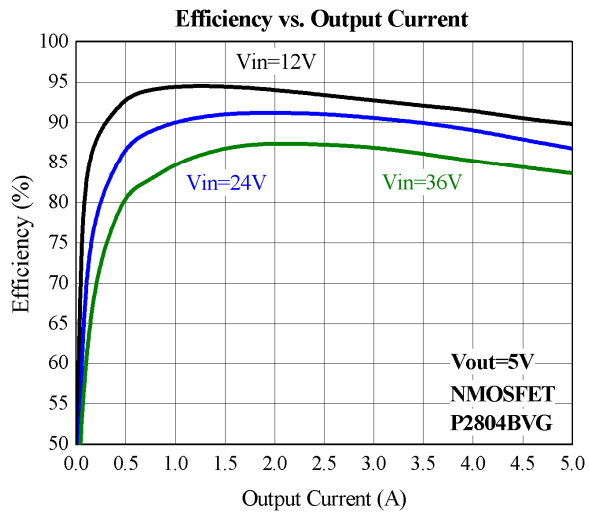

## Typical Operating Characteristics (continued)

$V_{IN}=12V$ ,  $V_{OUT}=5V$ ,  $T_A=25^\circ C$ , unless otherwise noted.

### Steady State

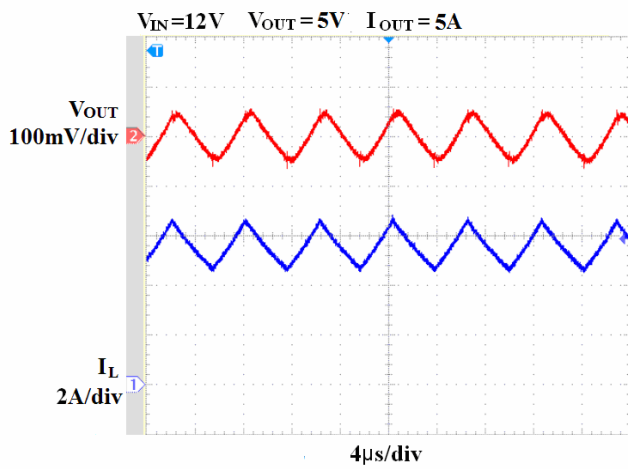

### Steady State

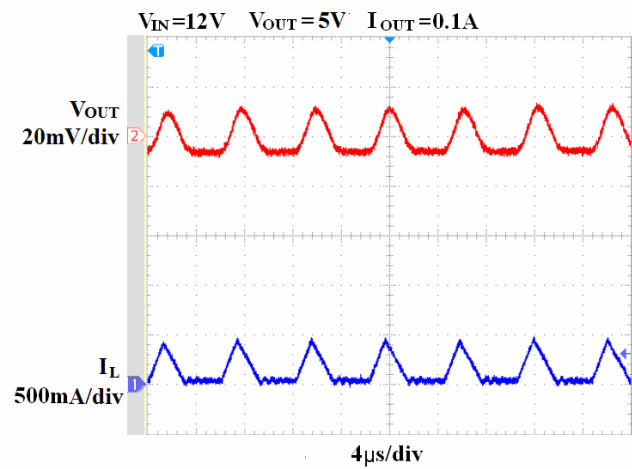

### Power On

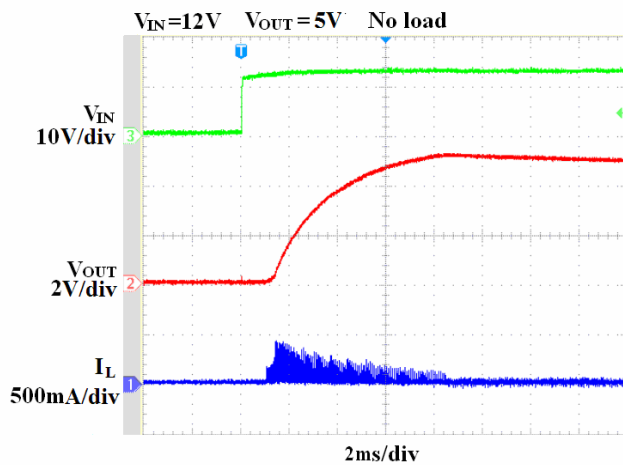

### Power On

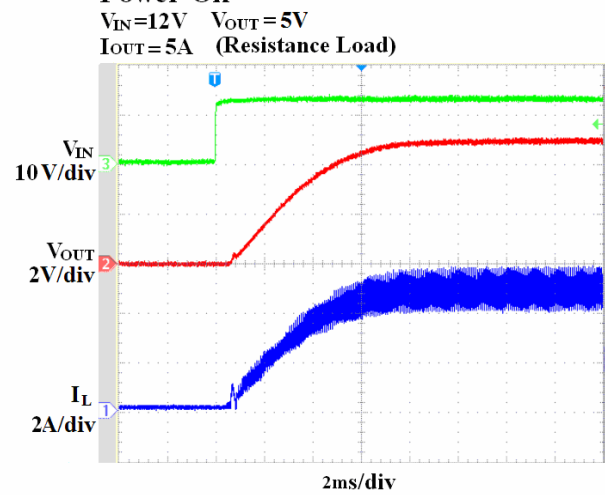

### Startup into CC mode

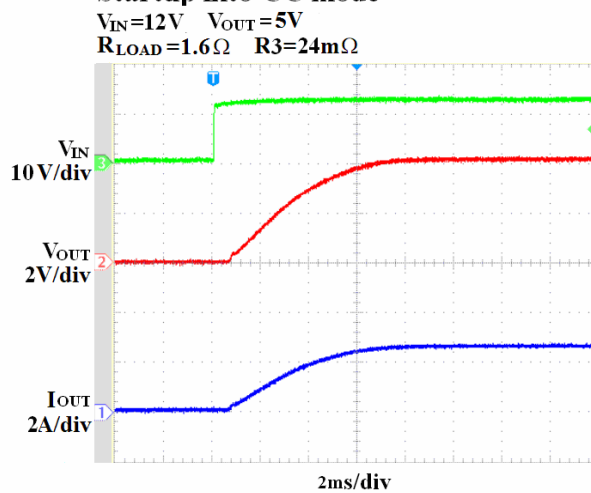

### Shutdown

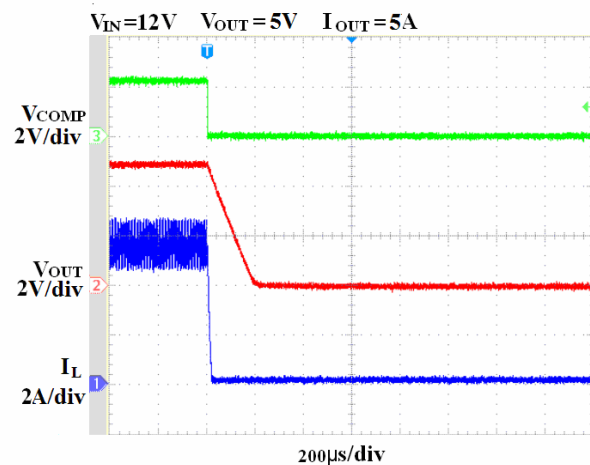

## Typical Operating Characteristics (continued)

$V_{IN}=12V$ ,  $V_{OUT}=5V$ ,  $T_A=25^\circ C$ , unless otherwise noted.

### CV mode to CC mode

$V_{IN}=12V$   $V_{OUT}=5V$   $R_3=24m\Omega$   
 $R_{LOAD}=2.5\Omega$  to  $1.25\Omega$

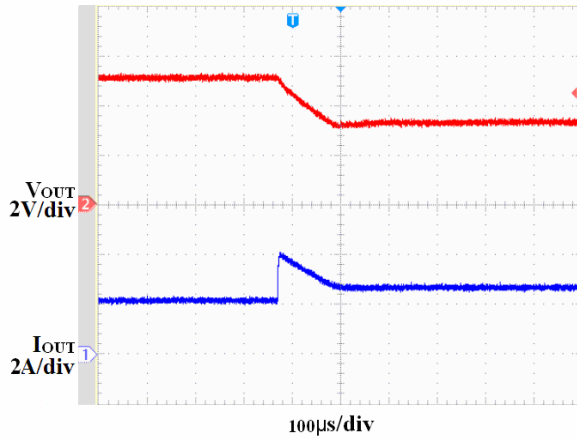

### CC mode to CV mode

$V_{IN}=12V$   $V_{OUT}=5V$   $R_3=24m\Omega$   
 $R_{LOAD}=1.25\Omega$  to  $2.5\Omega$

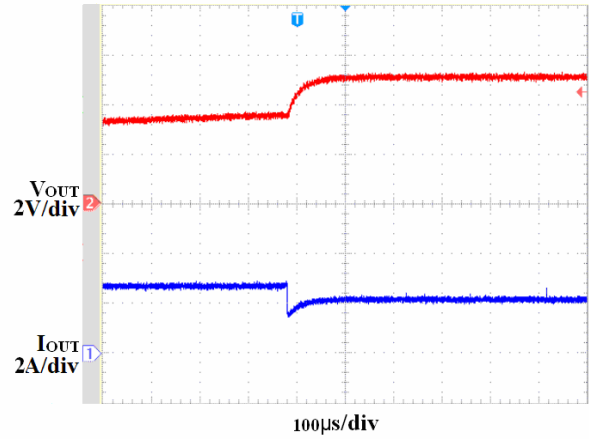

### Short Circuit

$V_{IN}=12V$   $V_{OUT}=5V$   $R_3=24m\Omega$

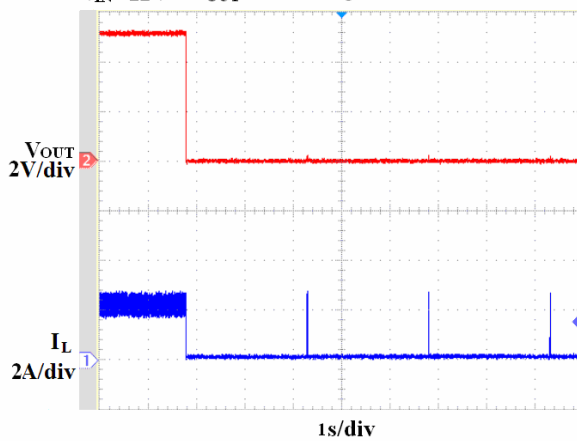

### Short Circuit Recovery

$V_{IN}=12V$   $V_{OUT}=5V$   $R_3=24m\Omega$

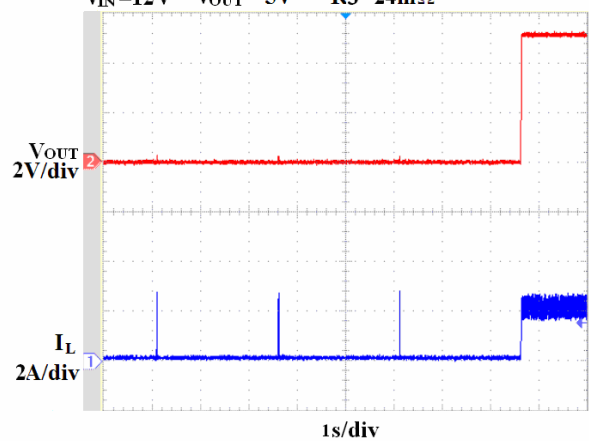

### Load Transient

$V_{IN}=12V$   $V_{OUT}=5V$   
 $I_{OUT}=0.1A$  to  $3A$

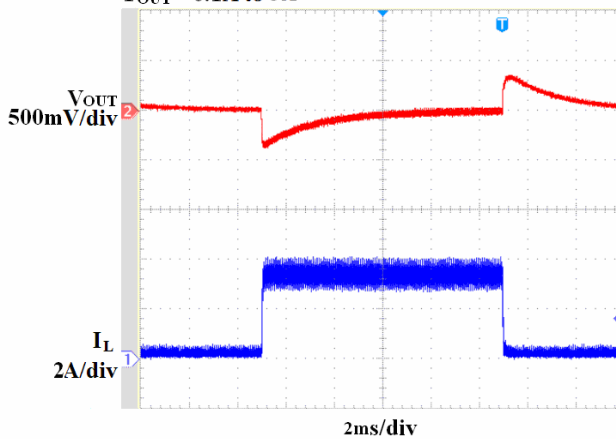

### Load Transient

$V_{IN}=12V$   $V_{OUT}=5V$   
 $I_{OUT}=2.5A$  to  $5A$

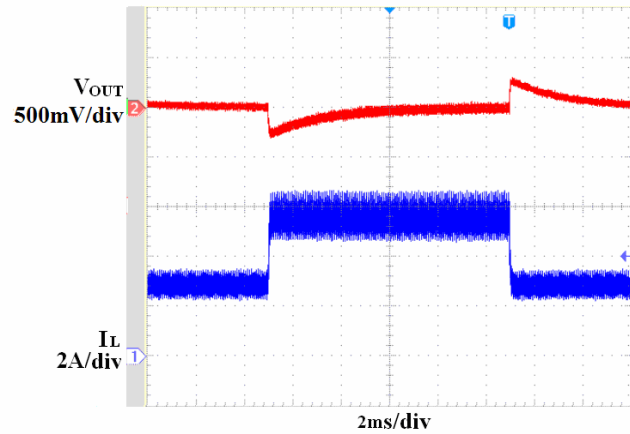

**Functional Description**

The EUP3468A is a current-mode synchronous step-down converter with 8V to 36V input power supply. The device can provide up to 5A continuous current to the output. The EUP3468A uses current-mode architecture to control the regulator loop. The output voltage is measured at FB through a resistive voltage divider and amplified through the internal error amplifier. The output current of the transconductance error amplifier is presented at COMP pin where a RC network compensates the regulator loop. Slope compensation is internally added to eliminate subharmonic oscillation at high duty cycle. The slope compensation adds voltage ramp to the inductor current signal which reduces maximum inductor peak current at high duty cycles.

**CC/CV mode control**

The EUP3468A operates in either CC mode or CV mode. The CV mode regulates the output voltage. When output current reaches the CC threshold, the device enters CC mode to limit the output current.

**Programmable cable compensation**

The EUP3468A provides programmable cable compensation by adjusting the external resistor divider to compensate resistive voltage drop across the charger's output cable.

**Internal soft-start**

Internal soft-start minimizes the inrush supply current and the output overshoot at initial startup.

**Over voltage protection**

OVP (over voltage protection) function with fixed OV (over voltage) threshold set by the internal resistor divider is provided. When output over voltage occurs, the device shuts down and returns to normal operation automatically when the output over voltage is released.

**Short circuit protection**

The EUP3468A provides the output short circuit protection function to prevent large output short circuit current from damaging the device. When output short happens, the device shuts down and returns to normal operation automatically when the short circuit condition is released.

**Thermal Shutdown**

The EUP3468A stops switching when its junction temperature exceeds 150°C and resumes when the temperature has dropped by 50°C to protect the device.

**Application Information**

The output voltage is set through a resistive voltage divider and can be expressed by the equation as follows

$$V_{OUT} = 0.6V \times (R1 + R2) / R2$$

**Setting the CC current**

EUP3468A channel 1 constant current value is set by the resistor R3 connected between the CS1 and GND pins. Channel 2 constant current value is set by the resistor R4 connected between the CS2 and GND pins. The CC current is determined by the equation as follows

$$I_{CS1} = 0.06V / R3$$

$$I_{CS2} = 0.06V / R4$$

**Setting the switching frequency**

The switching frequency is set by the resistor R6 connected between the FREQ and GND pins and can be expressed by the equation as follows

$$f_{SW} = 10^{11} / R6$$

The switching frequency is 160kHz when R6=0Ω.

**Setting the cable compensation**

The EUP3468A provides programmable cable voltage drop compensation using the impedance at the FB pin to compensate voltage drop across the charger's output cable. The cable compensation voltage can be expressed as

$$\Delta V_{OUT} = 15.35\mu \times (I_{OUT1} \times R3 + I_{OUT2} \times R4) \times R1$$

By adjust the value of R1, the cable compensation voltage can be programmed.



## Packaging Information

### SOP-8 (EP)

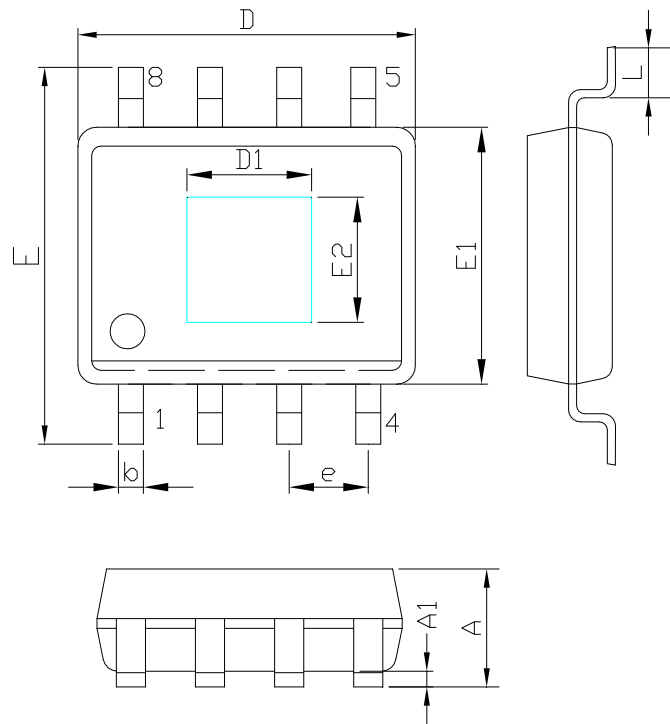

Remark: Exposed pad outline drawing is for reference only.

SYMBOLS	MILLIMETERS			INCHES		
	MIN.	Normal	MAX.	MIN.	Normal	MAX.
A	1.35	-	1.75	0.053	-	0.069
A1	0.00	-	0.25	0.000	-	0.010
D	4.80	4.90	5.00	0.189	0.193	0.197
E1	3.70	3.90	4.00	0.146	0.154	0.157
D1	2.67	2.97	3.50	0.105	0.117	0.138
E2	1.78	2.18	2.60	0.070	0.086	0.102
E	5.80	6.00	6.20	0.228	0.236	0.244
L	0.40	-	1.27	0.016	-	0.050
b	0.31	-	0.51	0.012	-	0.020
e	1.27 REF			0.050 REF		